

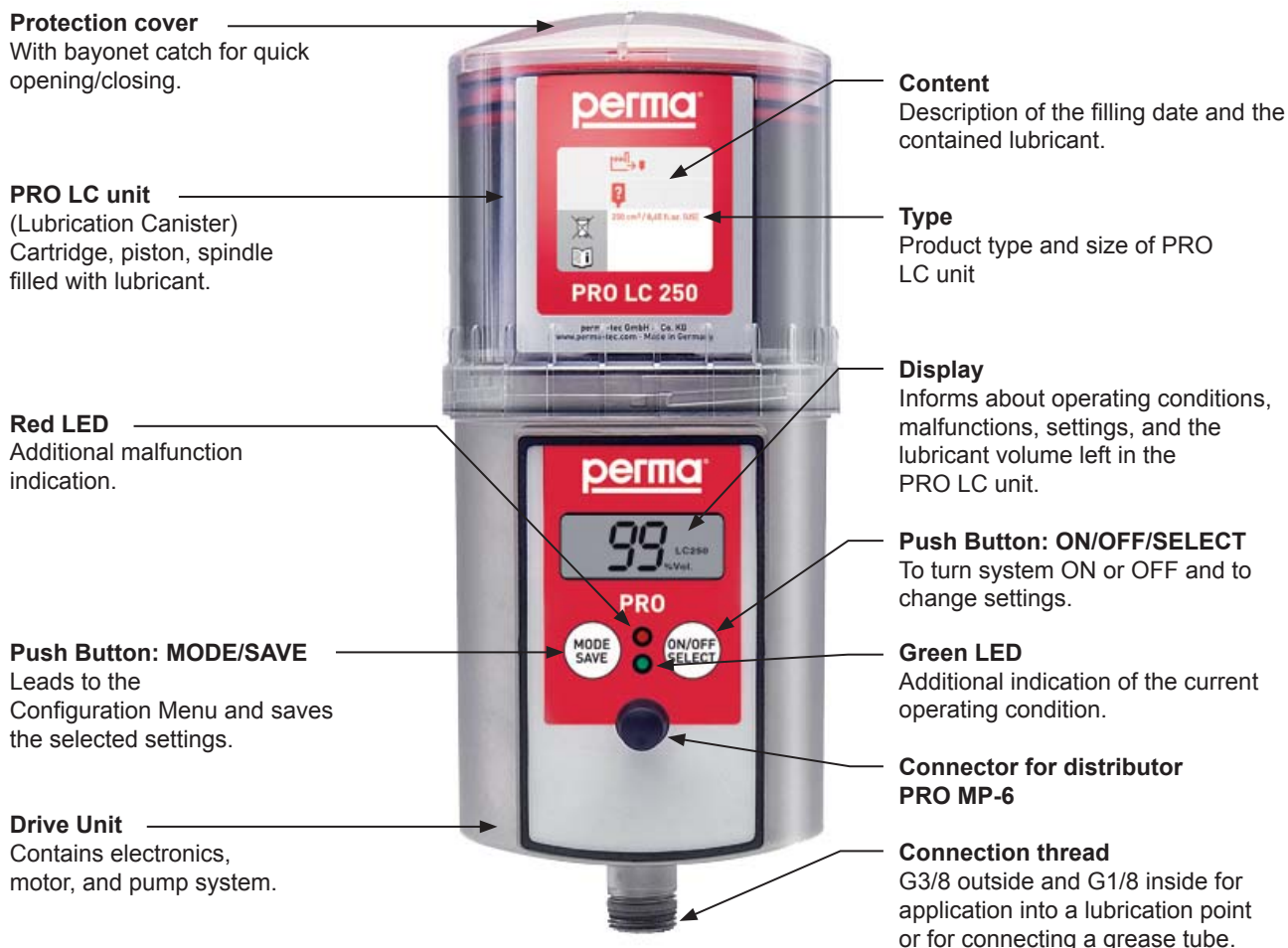

Translation of the  
Original Operating Instructions  
perma  
PRO 250 / 500

# Lubrication System perma PRO



## Display

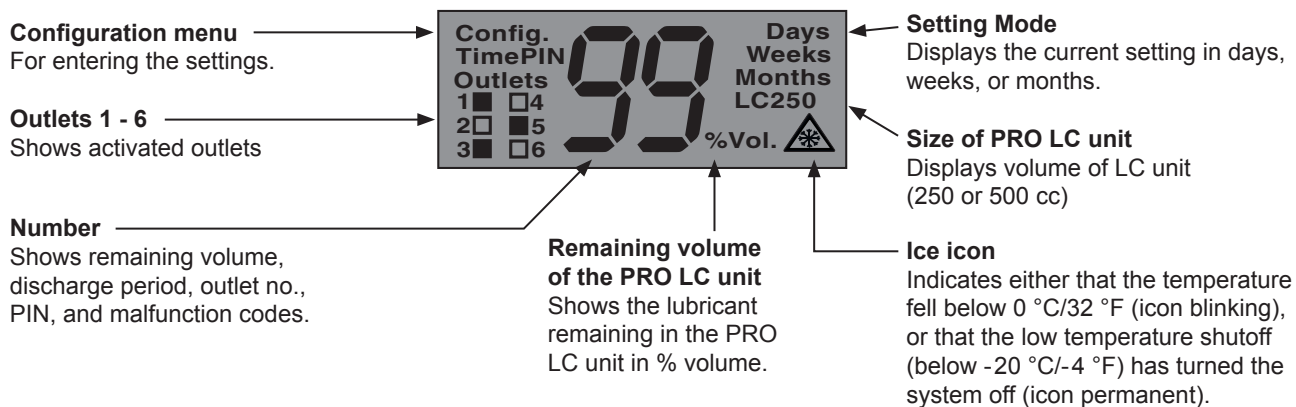

## Drive Unit

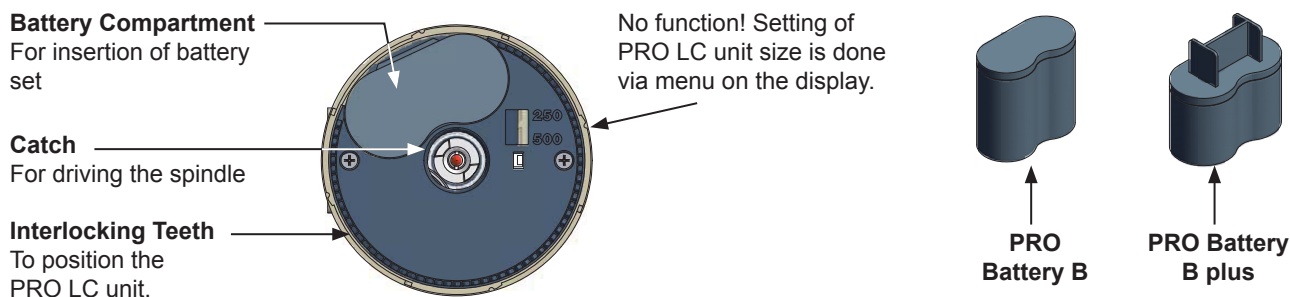

# Quick Reference Guide for the Lubrication System perma PRO

On this page you will find some important information for quick and easy operation and setting of the perma PRO. Before the first installation of the perma PRO, and whenever you need detailed instructions, you should read the complete Operating Manual which contains information that must be observed. Make sure to follow the instructions given in the chapter “Safety Notes”.

## 1 Assembly of perma PRO / Exchange of PRO LC unit (refer to chapters 4 and 7)

- ◆ Mount the drive unit on the mounting plate and secure it at the three pre-drilled holes (see attached template).
- ◆ Insert a new battery set into the battery compartment (follow directions of the arrows).
- ◆ Place the PRO LC unit inside the cover and remove the plug of the PRO LC unit.
- ◆ Push the PRO LC unit into the cover until lubricant comes out of the opening.
- ◆ Place the PRO LC unit with its cover on the drive-unit. Make sure that the catch locks and that the teeth of PRO LC unit and drive unit interlock.
- ◆ Turn the cover clockwise until the bayonet catch locks.

## 2 Determine Discharge Period (refer to chapter 6.7)

- ◆ Refer to the manufacturer’s guidelines about the lubrication point that you want to lubricate, in order to determine the required lubricant amount in cc per one hundred operating hours.
- ◆ Refer to chart 3 (chapter 6.7, chart 4) and find your required lubrication amount. Based on that, the chart will show you the required PRO LC unit size, the setting of the discharge period, and the setting mode.
- ◆ You may also refer to our perma Select program which can be downloaded from our web page free of charge. It helps you in selecting the correct settings.

## 3 Setting of LC unit Size, Discharge Period, Outlets and PIN (refer chapter 6.8)

- ◆ Hold down the MODE/SAVE button until the set time is displayed.
- ◆ Hold down the MODE/SAVE button again until you reach the current PIN (PIN cannot be changed here/PIN setting at delivery is “00”).
- ◆ Hold down the MODE/SAVE button again until you reach the other setting menus: LC unit, discharge period, outlets (only with attached MP-6), and PIN change. Change settings with a short push of MODE/SAVE or ON/OFF/SELECT.

## 4 Save Settings (refer chapter 6.8)

- ◆ Keep the MODE/SAVE button pressed until display shows “--”.

## 5 Starting perma PRO (refer chapter 6.5)

- ◆ Hold down the ON/OFF/SELECT button until the “Remaining Volume” appears in the display and the green LED starts blinking.

## 6 Stopping perma PRO (refer chapter 6.6)

- ◆ Keep the ON/OFF/SELECT button pressed until the display shows (“--”).

This operating manual is valid for the lubricator perma PRO with PRO LC units 250 cc and 500 cc.

© 2002 perma-tec GmbH & Co. KG

Without the specific approval of perma-tec GmbH & Co. KG no part of this documentation can be copied or made available to third parties.

We have taken great care when compiling all the details contained in this documentation. However, we cannot rule out discrepancies and we reserve the right to make technical changes to the product without giving advance notice.

We do not assume any judicial responsibility or liability for damages which may ensue as a result.

We will include any necessary changes in the next edition.

Compiled and printed: 11 / 02 / 2009

## Table of Contents

	<b>The lubrication system perma PRO</b>	<b>1</b>
	<b>Quick reference guide</b>	<b>2</b>
	<b>Content</b>	<b>3</b>
<b>1.</b>	<b>Various</b>	<b>4</b>
	1.1 Delivery / Content	
	1.2 Storage	
	1.3 Markings	
	1.4 Intended Usage	
	1.5 Legal Requirements	
<b>2.</b>	<b>Safety Instructions</b>	<b>6</b>
	2.1 Persons Responsible for Safety	
	2.2 General Safety Instructions	
	2.3 Safety Information for perma PRO	
<b>3.</b>	<b>Technical Data</b>	<b>7</b>
	3.1 Design of the perma PRO Lubricator	
<b>4.</b>	<b>Mounting and Assembly of the Lubrication System</b>	<b>9</b>
	4.1 Mounting the Drive Unit onto a Fixing Device for Wall-Mounting	
	4.2 Assembly of the Lubricator	
<b>5.</b>	<b>Display and Control Elements of the Lubrication System</b>	<b>12</b>
	5.1 Display Elements	
	5.2 Function Indication on the Display	
	5.3 Function Indication via the LEDs	
	5.4 Control Buttons	
<b>6.</b>	<b>Operation and Control</b>	<b>13</b>
	6.1 Preparations	
	6.2 Prior to Operation	
	6.3 Setting into Operation	
	6.4 During Operation	
	6.5 Switching the Lubrication System On	
	6.6 Switching the Lubrication System Off	
	6.7 Determining the Discharge Period	
	6.8 Settings and Display	
	6.9 Calculation of the Remaining Discharge Period	
<b>7.</b>	<b>Replacement of the PRO LC unit</b>	<b>19</b>
	7.1 Setting the Volume of the PRO LC unit	
	7.2 How to Replace the PRO LC unit	
<b>8.</b>	<b>Trouble Shooting</b>	<b>21</b>
	8.1 Error Messages on the Display	
	8.2 Trouble Shooting Guide	
<b>9.</b>	<b>Accessories and Spare Parts</b>	<b>22</b>
<b>10.</b>	<b>Disposal</b>	<b>24</b>
<b>11.</b>	<b>Service</b>	<b>24</b>
<b>12.</b>	<b>Declaration of conformity for perma PRO</b>	<b>25</b>

## 1. Various

### About this Operating Manual

- ◆ This operating manual is intended for the safe operation of the perma PRO automatic lubricator. It contains safety instructions which must be adhered to.
- ◆ Everyone who works on or with the lubricator must have access to this operating manual during their shift. They must also pay attention to all relevant instructions and notices.
- ◆ The operating manual must always be kept complete and in easy to read condition.

### Terms Used

- ◆ **Lubrication system perma PRO**  
In the following text, the "lubrication system perma PRO" will either be called "lubricator" or by its name "perma PRO".
- ◆ **Lubrication Canister**  
In the following text, the "Lubrication Canister" will be called PRO LC unit. The user can order the PRO LC unit with different lubricants and in size 250 cc and 500 cc.

### Usage of Safety Instructions

All safety instructions in this operating manual are standardized.

#### Danger Signs



This sign warns you of any danger to people's health or to subjects.

#### Tips



This sign alerts you to application tips which will help you in doing certain tasks quicker and safer.

### 1.1 Delivery / Content

- ◆ perma PRO will be delivered according to customer specifications in regards to type of grease and size of PRO LC unit.  
The user must only assemble it and adjust the desired settings.
- ◆ Mounting device and screws included.
- ◆ Operating instructions and EC Conformity Declaration included.  
Upon delivery, make sure to check if the delivered goods correspond to your order. perma-tec GmbH & Co. KG will not accept liability for subsequent claims of any shortcomings.
- ◆ Please immediately forward any claims:
  - of noticeable transport damage: directly to the forwarder.
  - of noticeable faults, shortcomings or defects: directly to your perma distributor.

### 1.2 Storage

When the lubricators are not immediately installed, you must ensure appropriate storage conditions in dry, dust free places with a temperature of  $+20\text{ °C} \pm 5\text{ °C}$  ( $+68\text{ °F} \pm 9\text{ °F}$ ).

Make sure that PRO LC units and battery sets are not stored longer than one year. Drive unit protection (1) during storage: do not remove cover disc (2) and plug (3) until right before you intend to use the lubricator (see chapt. 6.2).

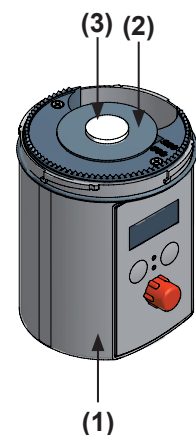

### 1.3 Markings

- ◆ The lubricator perma PRO is clearly marked with a label (serial number) on the drive system and a label on the PRO LC unit.
- ◆ **CE mark** on the drive unit.
- ◆ **UL mark** on the drive unit:  
“This equipment is suitable for use in Class I, Div. 2, Groups A, B, C and D; or Non-Hazardous Locations only. Warning - Explosions Hazard - Substitution of components may impair suitability for Class I, Division 2.”
- ◆ Manufacturer:

perma-tec GmbH & Co. KG  
Hammelburger Straße 21  
97717 Euerdorf  
Germany

Tel: +49 (0) 9704 609-0  
Fax: +49 (0) 9704 609-50

E-mail: info@perma-tec.com  
Homepage: www.perma-tec.com

### 1.4 Intended Usage

The lubricator perma PRO

- ◆ immediately supplies all lubrication points with lubricant, at a **pressure build-up of max. 25 bar** (360 psi.), permanently, precisely and independent of temperature.
- ◆ has passed the environmental audit according to standard EN 60068-2-6 (vibration test) without any component damage or malfunctions. In test: PRO drive unit with MP-6, PRO LC unit 500 cc, and mounting device in various mounting positions.
- ◆ can be used for all lubrication points of sliding- and roller bearings, drive- and transport chains, sliding guideways, open gears and seals.
- ◆ should only be connected to/used with original lubrication tubes from perma-tec GmbH & Co. KG.
- ◆ is intended for use on machinery and equipment.
- ◆ is only to be used for the ordered purpose and purposes confirmed by perma-tec.
- ◆ is only to be used for operating conditions recommended in this operating manual.
- ◆ is only to be used with settings and variations recommended in this operating manual.



**Any other usage, setting, addition, and variation is considered to be inappropriate!**

### 1.5 Legal Requirements

#### Liability

- ◆ The information, data and tips stated in this operating manual were up-to-date as of the printing date. No claims for already delivered lubricators perma PRO can be made based on the information, pictures and descriptions.
- ◆ perma-tec GmbH & Co. KG can not be held liable for damages and malfunctions caused by:
  - inappropriate usage;
  - unauthorized alterations to the drive system or the PRO LC unit;
  - inappropriate operations on or with the lubricator;
  - incorrect operation and settings of the lubricator;
  - incorrect settings of time and size of the lubricator;
  - ignoring the operating manual.

#### Warranty

- ◆ Warranty terms and conditions: see terms and conditions of sale and delivery appertaining to perma-tec GmbH & Co. KG.
- ◆ Lodge any warranty claims with your local supplier immediately after the defect or error has been identified.
- ◆ The warranty expires in all instances where no liability claims can be enforced.

## 2. Safety Instructions

### 2.1 Persons Responsible for Safety

- ◆ The operator or his safety officer must warrant,
  - that all the relevant regulations, instructions and laws are adhered to;
  - that only qualified personnel will work with and on the lubricator;
  - that unauthorized personnel are not allowed to work with and on the lubricator;
  - that the safety regulations are adhered to when mounting the lubricator or during maintenance.

### 2.2 General Safety Instructions

- ◆ We are not laying claim to completeness in regards to these safety instructions. Please contact perma-tec Customer Service if you have any questions or problems.
- ◆ At the time of delivery the lubricator is in line with state-of-the-art technology and in principle is considered to be safe to operate.
- ◆ Dangers emanate from the lubricator for persons, the lubricator itself and for other material assets of the operator if:
  - unqualified personnel operates the lubricator;
  - the lubricator is used inappropriately and for operations that it was not intended to be used for;
  - the lubricator setting / variation is incorrect;
  - the lubricator is opened by force while in operation;
  - the lubricator is not mounted with the perma mounting device;
  - the tube connection to the lubrication point was not carried out and attached correctly;
- ◆ Operate the lubricator only when it is in perfect condition.
- ◆ Retrofitting, changing, or reconstructing the lubricator is prohibited. perma-tec must be consulted first.
- ◆ Only original tube connections and connectors from perma-tec can be used on or with the lubrication system since these will withhold high pressures of up to 25 bar (360psi).
- ◆ Ambient media, especially chemically aggressive substances, can attack seals and plastic.

### 2.3 Safety Information for perma PRO



#### Safety during Installation and Maintenance

- ◆ Ensure that all workstations and traffic routes are clean and safe!
- ◆ Ensure that the relevant regulations and guidelines are adhered to when the installation or maintenance work is carried out in places where danger of falling exists.
- ◆ Ensure that the relevant safety and operating instructions are observed when the lubricators are installed or serviced on machines or in factories (i.e. to stop the machine).



#### Safety when Handling the PRO LC unit

- ◆ Avoid contact of lubricant with eyes, skin, and clothing!
- ◆ Avoid swallowing of lubricant!
- ◆ Prevent lubricant from getting into soil or sewer system!
- ◆ Observe safety data sheets of lubricants!  
You may also download data sheets of lubricants supplied by perma-tec from perma-tec's web page ([www.perma-tec.com](http://www.perma-tec.com)) or ask your local supplier.
- ◆ Lubricant on traffic ways will increase the danger of slipping! Therefore, immediately clean lubricant from floors with special cleaner.
- ◆ Only use original PRO LC units from perma-tec!



#### Safety when Handling Batteries!

- ◆ Avoid contact of battery substances with eyes, skin and clothing!
- ◆ Avoid swallowing any leaking battery substances!
- ◆ Do not expose batteries to extreme heat and do not throw into open fire!
- ◆ Do not recharge batteries!
- ◆ Ensure that regulations for waste disposal of batteries are observed!
- ◆ Only use original battery sets from perma-tec!

3. Technical Data

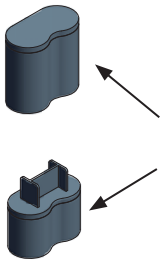
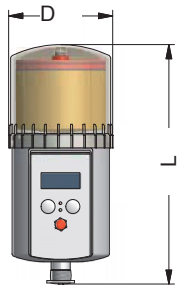

	PRO 250	PRO 500
Volume of the PRO LC unit	250 cc	500 cc
Length (L)	210 mm	260 mm
Diameter (D)	92 mm	92 mm
Weight, empty	1.30 kg	1.37 kg
Weight, filled with SF04	1.53 kg	1.82 kg
Discharge period	1 day to 24 months	1 day to 12 months
Discharged volume per lubrication impulse	0.5 cc	
Application temperature	-20 °C to +60 °C / -4 °F to +140 °F	
Maximum pressure build-up	25 bar / 360 psi	Combination of these Maximum-Values can only be realized by temperatures of $\geq 20$ °C/ 68 °F. At lower temperatures, the application is limited according to the diagram below.
Maximum tube length (inner-Ø 5mm)	5 m	
Lubricants	Greases up to rated consistency NLGI 2	
Power supply (0 °C to +60 °C / +32 °F to +140 °F)	Battery set PRO B (3 V alkaline manganese, not rechargeable)	
Power supply, low temperature (-20 °C to +60 °C / -4 °F to +140 °F)	Battery set PRO B PLUS (3 V lithium, not rechargeable)	
Emission sound pressure level	< 70 dB(A)	
Connection thread	G3/8 outside – G1/8 inside	
Protection class	IP 54	

figure 1

chart 1

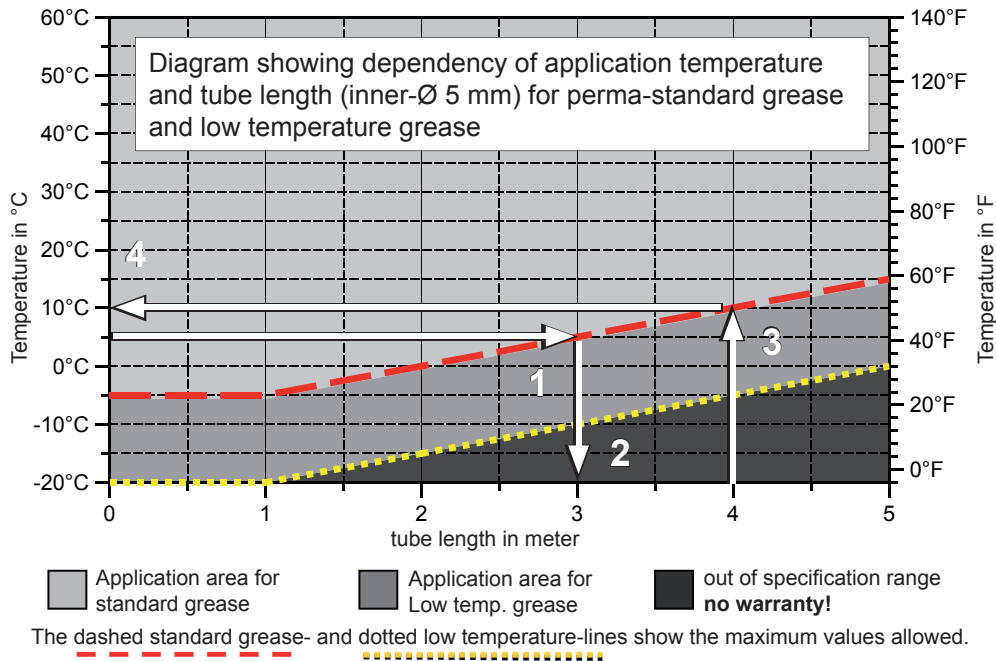

**If your application is out of the specification range shown in this diagram, please contact your local distributor. perma-tec cannot be held liable for these applications.**

Example:

- The application temperature is +5 °C / +41 °F. What is the maximum tube length allowed for standard grease?  
Correct Answer: 3 m max. tube length for standard grease, 5 m max. tube length for low temp. grease (arrow 1 meets the dashed line of the standard grease range at 3 m).
- You want to use a 4 m tube. Up to which temperature can the system be used?  
Correct Answer: +10 °C / 50 °F with standard grease -5 °C / 23 °F with low temp. grease (arrow 3 meets the dotted line of low temp. grease at the -5 °C mark; and the dashed line of the standard grease at the +10 °C mark).

### 3.1 Design of the perma PRO Lubricator

Lubricators are available as 250 cc and 500 cc versions and they can be supplied with the lubricant requested by the customer. They consist of (refer to figure 2):

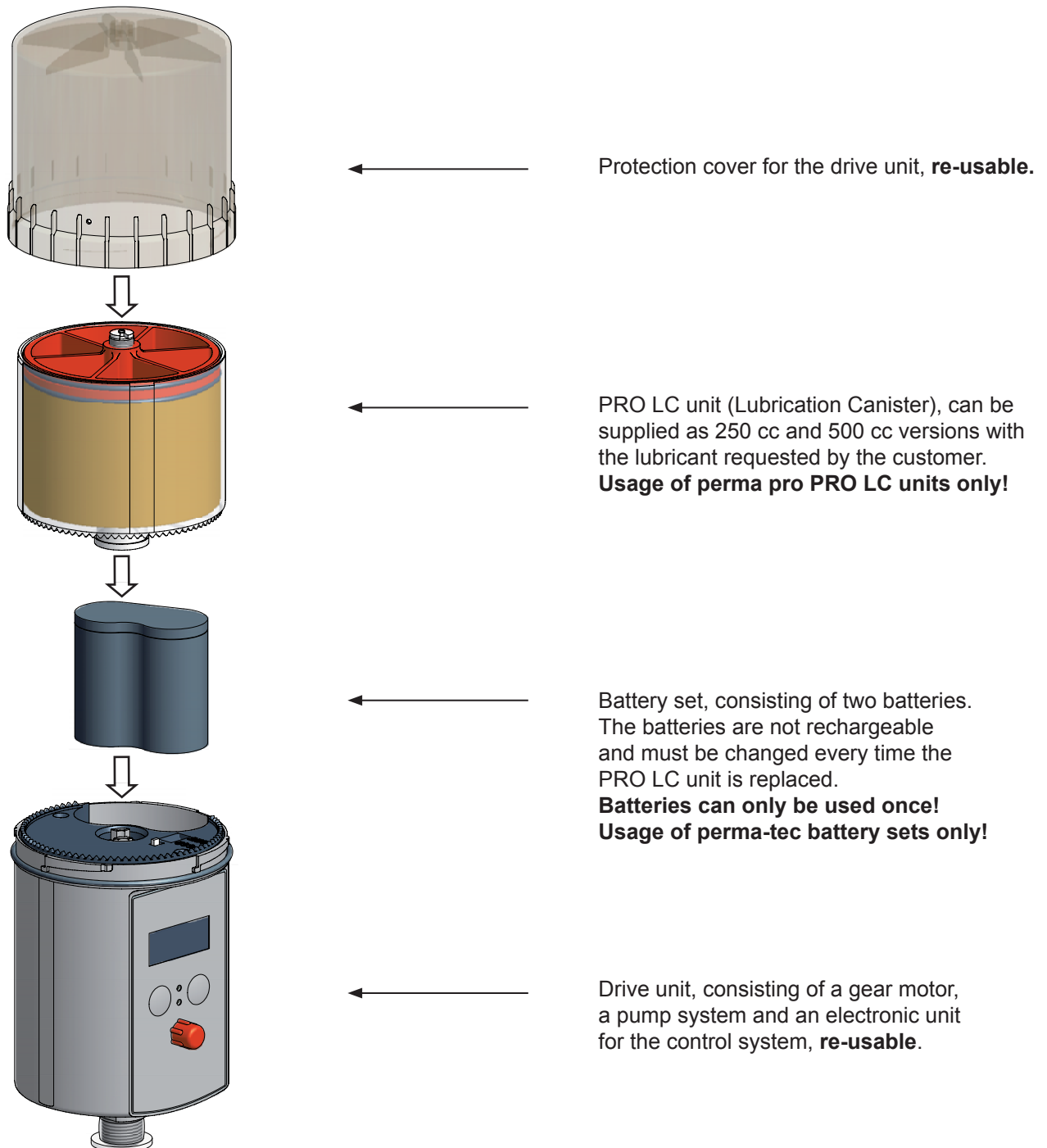

figure 2

## 4. Mounting and Assembly of the Lubrication System

### 4.1 Mounting the Drive Unit onto a Fixing Device for Wall-Mounting

- ◆ Attach the supplied mounting device to the drive unit using the two enclosed hex head bolts (M6 x 16) and the two washers.
- ◆ Screw the mounting device with the drive unit onto a support of your system.  
The boring template of the three mounting screws (141.5 x 45) can be seen below in picture 3 or on the template that is included. You have to use at least three hexagon screws M6 x 25 (e.g. on metal ground).
- ◆ Before you connect the outlet of the drive unit to the lubricant tube, you have to make sure that the lubrication points and the complete lubricant tube is pre-lubricated with the same lubricant that is contained in the PRO LC unit. For that, perma-tec offers a 400 g lubrication cartridge for manually-operated grease presses with the requested lubricant.
- ◆ Connect the lubricant tube (connection G3/8 outside or G1/8 inside) to the outlet of the drive unit and install the tube correctly between the outlet and the lubrication point. The lubricant tube must not be longer than five meters.

 **Make sure that you assemble the connections and lubricant tubes correctly and tightly to avoid possible leakage.**

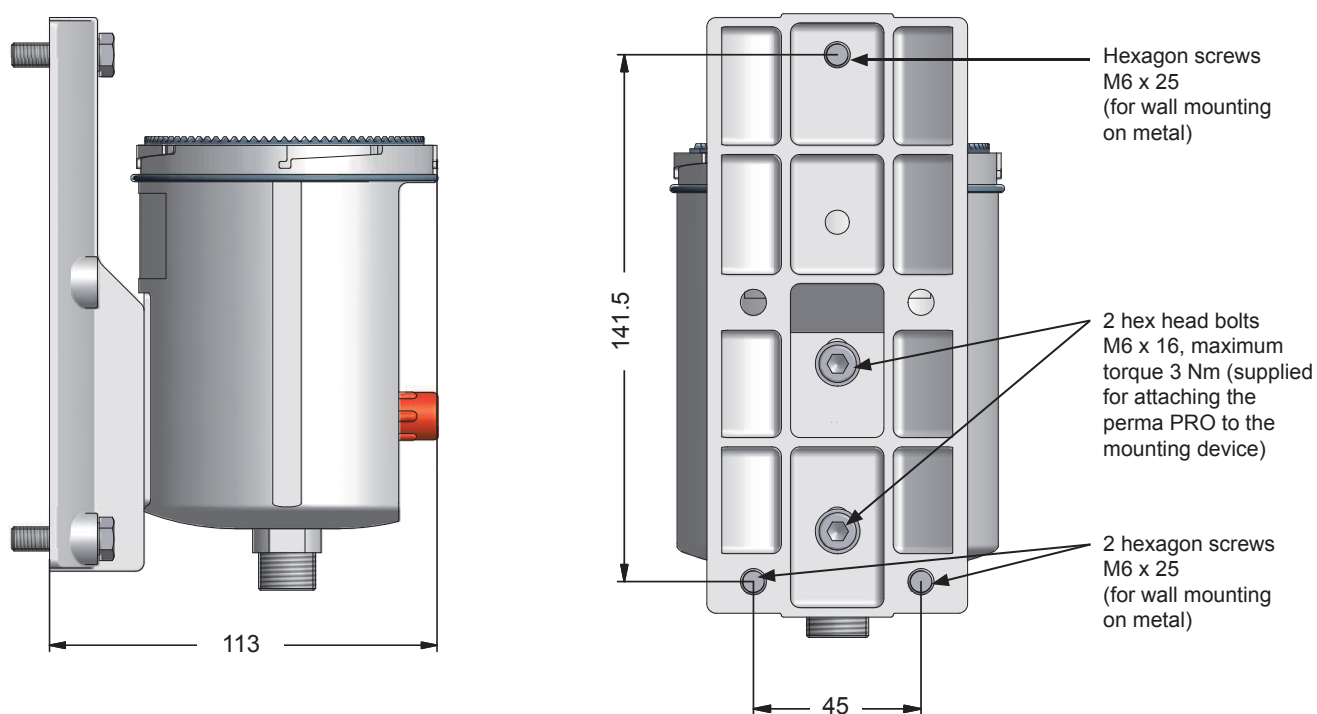

figure 3

## 4.2 Assembly of the Lubricator

a)

- ◆ Insert the battery set into the drive unit (according to the direction of the arrow on the label).

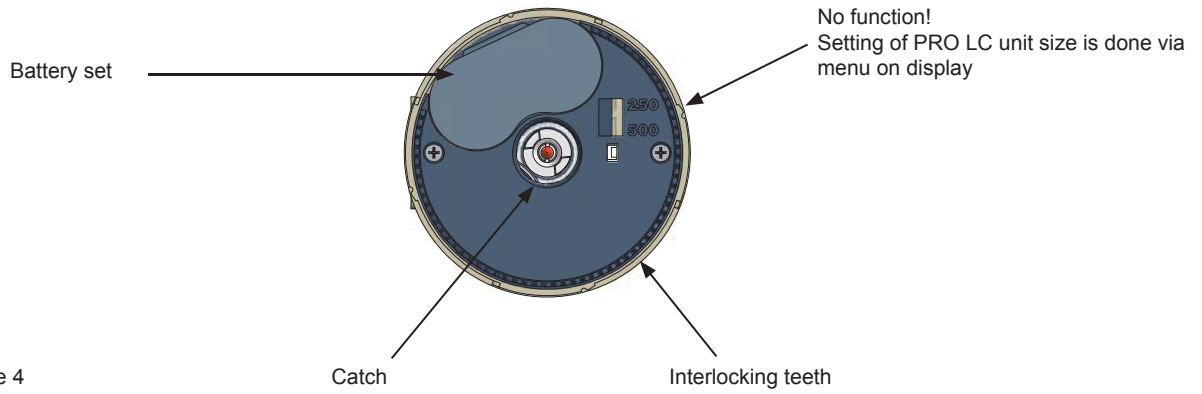

figure 4

b)

- ◆ Place the PRO LC unit inside the protection cover and remove the plug of the PRO LC unit (refer to figure 5).

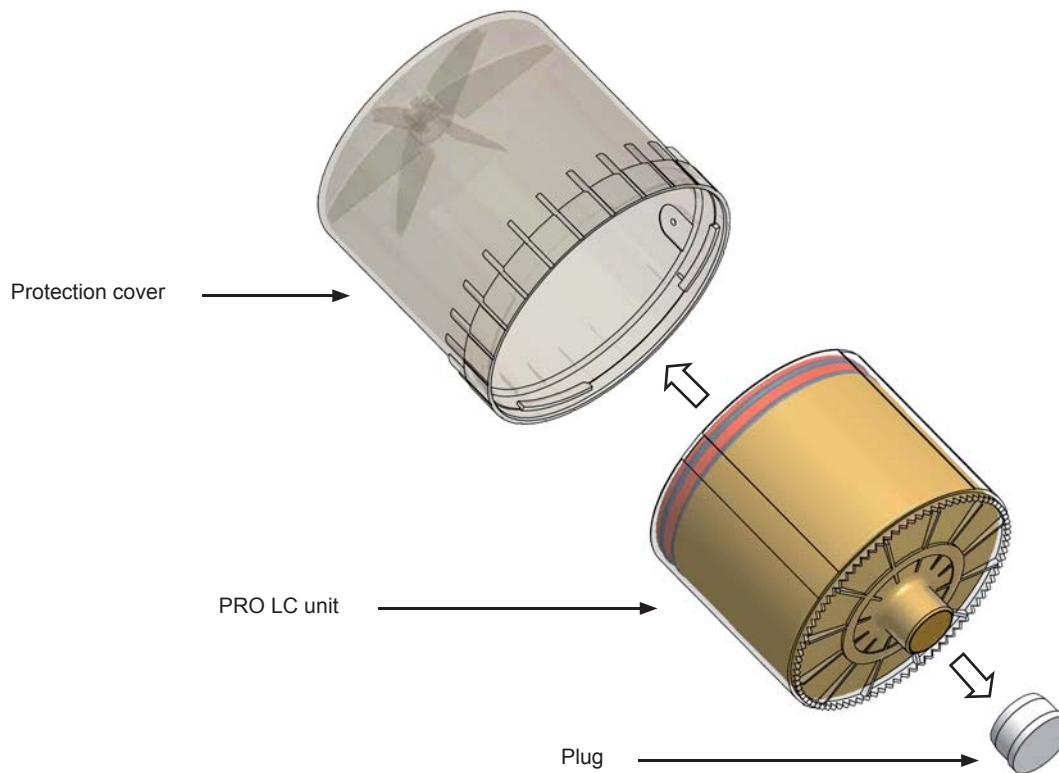

figure 5

c)



- ◆ Push the PRO LC unit into the protection cover until lubricant comes out of the opening (refer to figure 6).

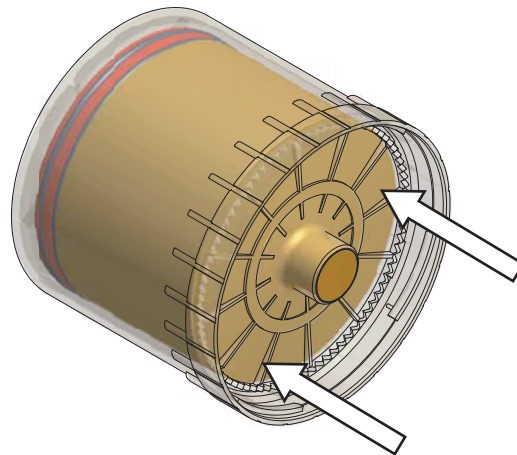

figure 6

d)

- ◆ Place the PRO LC unit with its protection cover on the drive-unit. Make sure that the catch locks and that the teeth of the PRO LC unit and the drive unit interlock (refer to figure 4 and figure 7).
- ◆ Turn the cover clockwise until the bayonet catch locks.

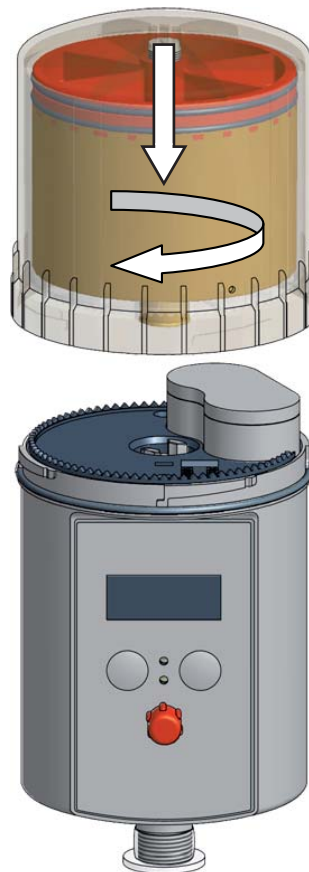

figure 7

## 5. Display and Control Elements of the Lubrication System

### 5.1 Display Elements

The operating status of the lubricator can be determined via the green or the red LED and via the display at the control unit (refer to figure 8) of the perma PRO.

The perma PRO offers a menu-guided setting. Changes of the settings are shown on the display. Error messages, e.g. in case the pressure in the lubricant tube gets too high, are also indicated on the display.



figure 8

### 5.2 Function Indication on the Display

The display is located on the control unit of the perma PRO (refer to figure 8, chapter 5.1). The display shows settings, operating conditions and error messages of the lubricator.

In case of an error free operation of the lubrication system, the display shows the remaining volume of the mounted PRO LC unit in percent volume (% Vol.). Figure 9 shows an example of the displayed information if the PRO LC 500-unit is new and full.



figure 9

**The display cannot be switched off by the operator. If the lubrication system is switched off, the display will always show two lines (see figure 10 below).**



figure 10

### 5.3 Function Indication via the LEDs

LED	Signal	Signal Length	Explanation
green	flash	every 10 seconds	operation (OK)
red	flash	every 3 seconds	error / malfunction
green and red	flash	every 3 seconds	PRO LC unit empty
green	light	permanently	Lubricator is discharging
green and red	none	none	Lubricator switched off or battery low

chart 2

## 5.4 Control Buttons

There are two push-buttons on the control unit (refer to figure 8) which can be used for a menu-guided change of the settings.

- ◆ With the MODE/SAVE button (refer to figure 11), you can reach the configuration menu, change the mode and save the modified settings for further operation.
- ◆ With the ON/OFF SELECT button (refer to figure 12) you can do the following: turn lubricator On/Off, increase discharge period (Days, Weeks, Months - each time you press the button increases the discharge period by one calendar unit), change PRO LC unit size, activate MP-6 outlets and set PIN.





PRESS	Short	Short	Long >4 sec. until the display content changes completely	Long >4 sec. until the display content changes completely
BUTTON	 figure 11	 figure 12	 figure 11	 figure 12
FUNCTION	Selection in current display	Changing of values	Moves to new menu and saves selected values	Returns to original menu without saving changes

chart 3, figure 11, figure 12

## 6. Operation and Control

### 6.1 Preparations

- ◆ Prior to the installation of the lubricator, the lubrication point and the complete connection tube must be sufficiently prelubricated with the same lubricant that the PRO LC unit contains. For this, perma-tec offers a 400 g lubrication cartridge for grease presses with the corresponding lubricant (refer to chart 8b, chapter 9).
- ◆ When installing the perma PRO, the supplied perma-tec mounting device should be used.
- ◆ The lubricant tube must be installed and mounted correctly. The length of the lubricant tube may not exceed a maximum of 5 meters and the tube must be a perma-tec product.
- ◆ Please check if the thread of the perma PRO (G3/8 or G1/8) corresponds to the connection thread of the lubrication point. If this is not the case, you can order a corresponding reducer or other parts from the perma accessory range.



For the initial setting into operation of a perma PRO, the pump system in the drive unit is pre-filled with SF04 from perma's standard range of lubricants. An exception is made with regard to lubricants for the food industry. A complete discharge of this pump filling is guaranteed after approx. 10 discharges (carry out additional discharges, if necessary).

### 6.2 Prior to Operation

- ◆ Check all parts of the lubricator for obvious damages!
- ◆ Is the new PRO LC unit filled with the required lubricant?
- ◆ Did you insert a new battery set?
- ◆ Has the cover disc with plug been removed from drive unit (see chapter 1.2)?
- ◆ Did you assemble and mount all of the parts correctly and tightly?

### 6.3 Setting into Operation

- ◆ If necessary, mount the drive unit onto a fixing device for wall-mounting (refer to chapter 4.1).
- ◆ Insert the battery set into the drive unit and the PRO LC unit into the protection cover and close the complete system (refer to chapters 4.2 b - d).
- ◆ Determine the discharge period (refer to chapter 6.7).
- ◆ Set volume of PRO LC unit, discharge period, outlets of MP-6, and the PIN via buttons on display (refer to chapter 6.8).
- ◆ Switch-on the lubrication system (refer to chapter 6.5).
- ◆ Carry out an additional discharge (refer to chapter 6.8).  
If the drive motor has started and the green LED is lit, the lubricator has started to discharge. The display indicates the remaining volume (% Vol.) of the PRO LC unit.



**The operator must always check the customer-specific settings and if necessary change them before the lubricator is set into operation!**

### 6.4 During Operation

- ◆ Carry out regular inspections during the operation. You should pay special attention with regard to leakage and to the condition of the lubricator!
- ◆ Check the condition of the lubricant tube and the connections regularly!
- ◆ Check the filling level of the transparent PRO LC unit regularly!
- ◆ After one or several additional discharges, you have to calculate the reduced discharge period and note this on your lubrication and maintenance schedule.
- ◆ If a malfunction is indicated on the display, you can determine the cause using the trouble shooting guide (refer to chart 7, chapter 8.2). If the fault cannot be fixed, please contact your supplier for technical support.



**Additional discharges and long machine standstills must always be taken into account with regard to the remaining discharge period of the lubricator.**

### 6.5 Switching the Lubrication System On

To switch the lubrication system on (refer to figure 13), keep the ON/OFF/SELECT button pressed until the indication (“--”) on the display is replaced by an indication of the remaining volume – e.g. 99 % VOL (with a new PRO LC unit) – and the green LED starts blinking.



figure 13

### 6.6 Switching the Lubrication System Off

To switch the lubrication system off (refer to figure 14), keep the ON/OFF/SELECT button pressed until the display no longer indicates the remaining volume – % VOL – but indicates (“--”) instead. When the lubrication system is switched off, all of the settings are saved. This means that if you start the lubricator again, it will take up the operation at the point where it had been switched off.



figure 14

## 6.7 Determining the Discharge Period



The discharge period is automatically factory-set to six months according to the supplied PRO LC unit. Upon request, a factory-setting of the discharge period required by the customer is also possible. The size of the PRO LC unit is taken into account.

If you want to determine the discharge period, you need to know the required amount of the lubricant in cubic centimeters for 100 operating hours (cc/100 h). This information can be taken from the technical documents of the manufacturer of the lubrication point.

With this information, you can determine the discharge period using the following chart (chart 4).

		Average discharge volume in cc per 100 operating hours					
PRO LC unit		250			500		
Setting point Discharge period	Setting mode	Days	Weeks	Months	Days	Weeks	Months
	1		1041.7	148.8	34.3	2083.3	297.6
2		520.8	74.4	17.1	1041.7	148.8	34.3
3		347.2	49.6	11.4	694.4	99.2	22.8
4		260.4	37.2	8.6	520.8	74.4	17.1
5		208.3	29.8	6.9	416.7	59.5	13.7
6		173.6	24.8	5.7	347.2	49.6	11.4
7		148.8	21.3	4.9	297.6	42.5	9.8
8		130.2	18.6	4.3	260.4	37.2	8.6
9		115.7	16.5	3.8	231.5	33.1	7.6
10		104.2	14.9	3.4	208.3	29.8	6.9
11		94.7	13.5	3.1	189.4	27.1	6.2
12		86.8	12.4	2.9	173.6	24.8	5.7
13		80.1	11.4	2.6	160.3	22.9	--
14		74.4	10.6	2.4	148.8	21.3	--
15		69.4	9.9	2.3	138.9	19.8	--
16		65.1	9.3	2.1	130.2	18.6	--
17		61.3	8.8	2.0	122.5	17.5	--
18		57.9	8.3	1.9	115.7	16.5	--
19		54.8	7.8	1.8	109.6	15.7	--
20		52.1	7.4	1.7	104.2	14.9	--
21		49.6	7.1	1.6	99.2	14.2	--
22		47.3	6.8	1.6	94.7	13.5	--
23		45.3	6.5	1.5	90.6	12.9	--
24		43.4	6.2	1.4	86.8	12.4	--
25		41.7	--	--	83.3	--	--
26		40.1	--	--	80.1	--	--
27		38.6	--	--	77.2	--	--
28		37.2	--	--	74.4	--	--
29		35.9	--	--	71.8	--	--
30		34.7	--	--	69.4	--	--

chart 4



Please take into account that in case of one or several additional discharges, the remaining discharge period of the lubrication system must be recalculated (refer to chapter 6.7). This also applies in case of a cut-off of the lubrication system due to a long machine standstill (e.g. weekends or annual holidays). You should also note the result of your calculation of the remaining discharge period in your lubrication and maintenance schedule.



**The perma SELECT software helps you to determine the discharge period.**  
**Visit our website [www.perma-tec.com](http://www.perma-tec.com) for a free download of this software.**

6.8 Settings and Display  
(see caption on page 17)

MODE SAVE	Display	ON/OFF SELECT	Meaning / Description	
	--		Display at delivery with attached PRO LC unit	
↓ MODE SAVE	Time 06 Months		Shows discharge period PIN-reset	Info
↓ MODE SAVE	PIN 00	Change first digit ↓ ON/OFF SELECT	Enter first digit of current PIN PIN "00" at delivery	PIN Entry
↓ MODE SAVE	PIN 00	Change second digit ↓ ON/OFF SELECT	Enter second digit of current PIN	
↓ MODE SAVE	Config. LC LC 500	Change from LC500 to LC250 ↓ ON/OFF SELECT	Set LC unit size	LC
↓ MODE SAVE	Config. Time 06 Months	Change Months ↓ ON/OFF SELECT	Set discharge period: Either <b>Months</b> , <b>Weeks</b> , or <b>Days</b>	Time
↓ MODE SAVE	Config. Time 01 Weeks	Change Days or Weeks ↓ ON/OFF SELECT	Set discharge period: Go to "Days" or "Weeks"	
↓ MODE SAVE	Config. Outlets 1 1 <input type="checkbox"/> 4 2 <input type="checkbox"/> 5 3 <input type="checkbox"/> 6	Outlet 1 On / Off ↓ ON/OFF SELECT	Activate outlets: Activate outlet 1 Outlets only displayed if MP-6 is connected	Outlets
	Config. Outlets 1 1 <input checked="" type="checkbox"/> 4 2 <input type="checkbox"/> 5 3 <input type="checkbox"/> 6		Outlet 1 activated	
↓ MODE SAVE	Config. Outlets 2 1 <input type="checkbox"/> 4 2 <input checked="" type="checkbox"/> 5 3 <input type="checkbox"/> 6	Outlet 2 On / Off ↓ ON/OFF SELECT	Outlet 2 activated (if desired, other outlets may be turned On / Off the same way)	
↓   ↓ MODE SAVE   MODE SAVE	Config. PIN 00	Change first digit ↓ ON/OFF SELECT	PIN (first digit) enter for initial configuration or after a PIN-reset – otherwise, setting is complete	PIN
↓ MODE SAVE	Config. PIN 00	Change second digit ↓ ON/OFF SELECT	PIN (second digit) enter for initial configuration or after a PIN-reset	
↓ MODE SAVE	--		Configuration finished	

CONFIGURATION MENU INTRO

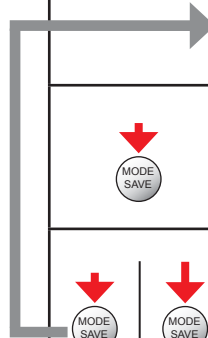

chart 5

### Caption for Chart on Left Side

Instructions should be followed from top to bottom and from left to right (also refer to chart. 3). The instructions correspond to the operating sequence on the turned-off lubrication system perma PRO. Configuration is also possible if perma PRO is On.

Function	short push	long push	blinking display	Go to
Symbol	↓	↓	⋯	→

chart 6

### Configuration sections (see vertical bar, chart 5)

#### INTRO

INTRO informs (INFO) and asks for the current PIN (PIN-entry). Settings can be changed in the configuration menu with its different sections (LC, Time, Outlets, PIN).

#### CONFIGURATION MENU

#### LC

You can change the PRO LC unit size from LC250 to LC500 and back by pushing the ON/OFF/SELECT button (refer to chapter 7.1 and 7.2).

#### Time

The discharge period can only be set in **one** type of calendar unit (i.e. either Months, Weeks or Days). When the highest unit size is reached, counting starts again with number "01".

#### Outlets

If a MP-6 distributor is connected, outlets 1 - 6 can be set individually. The activated outlets 1 - 6 are displayed with a filled-in square in the display (please refer to the operating instruction of the MP-6 distributor for more details).

#### PIN

We strongly suggest to enter a personal PIN in order to protect your settings from unauthorized access. The PIN can **only be changed during initial configuration or after a PIN-reset**. A PIN-reset (short push of buttons: left-left-right-right-left in the INTRO-Info-menu) changes your personal PIN back to "00". The PIN-reset was successful when the displayed time disappears for a second and then comes back on. All other settings remain unchanged.

### Save or Reject Changed Settings

The display settings can be saved with a long push of the MODE/SAVE button. If you do **not** want to save your changes to settings that are currently displayed in the configuration menu (LC, Time, Outlets, PIN), press the ON/OFF/SELECT button until the display shows either ("--") for Off or the remaining volume of the PRO LC unit in % VOL. All other settings and already saved changes remain valid.

### Automatic Termination of the Configuration Mode

If you do not press a button in the configuration menu for 180 seconds, the control system is automatically switching back to the previously set mode ("On" or "Off") without saving the changes. All other settings and already saved changes remain valid.

### Additional Discharge

With an additional discharge, a lubrication point can be supplied with an additional amount of the lubricant. For an additional discharge, the lubrication system must be switched on (display shows remaining volume) and you have to press both buttons simultaneously and hold them down (refer to figure 15).



figure 15

Lubricator On



For an additional discharge, press both buttons at the same time and hold them down.

An additional discharge is only possible at temperatures above 0 °C / 32 °F (figure 16, ice crystal is not visible) and when the lubrication system is not currently conducting a regular discharge.

Every additional discharge reduces the remaining discharge period since an increased amount of the lubricant has been supplied. This must be taken into account in your lubrication and maintenance schedule. A calculation is possible with the formula from chapter 6.9 and with the remaining volume which is displayed.

**The time between two additional discharges is 30 seconds. Each additional long push of both buttons (simultaneously, figure 15) during this time is being registered and will lead to even more additional discharges. The system remembers a max. of 5 additional discharges.**

## Low-Temperature Cut-Off of the Lubrication System

The temperature range from 0 °C to -19 °C (32 °F to -2.2 °F) is indicated by a blinking ice crystal symbol (refer to figure 16).

In this temperature range the lubrication system perma PRO continues to operate without interruption.

**Please note, that in this temperature range an additional discharge is not possible!**



figure 16

Display with a blinking ice crystal (in this example with 89 % Vol.)

In order to protect the system from damage, the low-temperature cut-off of the lubrication system is automatically carried out by the control system and the built-in temperature sensor.

If the temperature reaches or falls below -20 °C (-4 °F), the lubricator is switched off by the low-temperature cut-off and the ice crystal symbol is permanently indicated on the display. The remaining volume is still displayed in % Vol.



**From this time onwards, the lubricant is no longer discharged. You have to take this fact into account if your system continues to operate in order to prevent damages!**

As soon as the temperature rises and reaches -19 °C (-2.2 °F) or higher, the control system switches the lubrication system on.

The display shows the remaining volume and the blinking ice icon.



**All discharges (except additional discharges), accumulated during the shut-off, will be caught up when the system continues operation (at a max. of two additional discharges with every regular discharge).**

## 6.9 Calculation of the Remaining Discharge Period



Please note, that in case of one or several additional discharges, the remaining discharge period of the lubrication system must be recalculated. This also applies in case of a cut-off of the lubrication system due to a long machine standstill (e.g. weekends or annual holidays) or in case of a low-temperature cut-off carried out by the system if temperatures reach -20 °C (-4 °F).

You should also note the result of your calculation of the remaining discharge period in your lubrication and maintenance schedule.

$$\text{Formula: } R_{DP} = \frac{SDP * RV}{100}$$

SDP: Set Discharge Period of the lubricator (days, weeks, months)

RV: Remaining Volume (displayed in % Vol.)

$R_{DP}$ : Remaining discharge period (days, weeks, months depending on SDP)

### Example of a Calculation of the Remaining Discharge Period

The perma PRO with a 250 cc PRO LC unit was originally set to a discharge period (SDP) of eight months, since the lubrication point needs 4.3 cc lubricant /100 h. After two months, the perma PRO indicates a remaining volume (RV) of 75 % Vol. At this point, the lubricator is switched off for six weeks (e.g. machine standstill). When it is switched on again, you would like to determine when the PRO LC unit will be empty.

$$R_{DP} = \frac{SDP * RV}{100} = \frac{8 * 75}{100} = \frac{600}{100} = 6$$

This results in a remaining discharge period of six months. After these six months, the PRO LC unit will be empty and must be replaced by a new one.

## 7. Replacement of the PRO LC unit

### The Following Must Always Be Taken into Account

If the replacement of an empty PRO LC unit becomes necessary, it will be indicated by a simultaneous blinking of the red and the green LED. Additionally, the display indicates that the PRO LC unit is empty (refer to figure 17).



figure 17



**If you replace the PRO LC unit, you also have to change the battery set. Otherwise, the correct operation of the lubricator cannot be guaranteed!**

**If you replace the PRO LC unit by a PRO LC unit of a different size, a corresponding protection cover (refer to chart 8a, chapter 9) must be used.**



**Since the drive unit and the control board must be protected against moisture, an exchange may only be carried out in dry conditions!**

After the installation of the new PRO LC unit, the control system continues to operate using the previously valid setting of the discharge period.

### 7.1 Setting the Volume of the PRO LC unit

The size of the PRO LC unit must be set in the configuration menu with the two buttons on the drive unit (see figure 18). Please also refer to the operating chart (chart 5, chapter 6.8).



#### **ATTENTION!**

**If the displayed setting does not correspond with the attached PRO LC unit size it will result in incorrect discharge amounts and wrong signals in the display (Display, LEDs).**

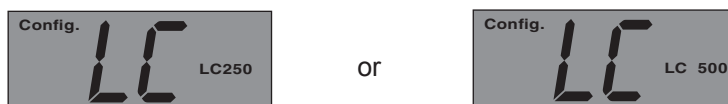

figure 18



#### **ATTENTION!**

Whenever a PRO LC unit is removed from the lubricator and is replaced by another LC unit, the control system assumes that a new, completely filled PRO LC unit was attached.

**Therefore NEVER attach a PRO LC unit that is not completely full!**

## 7.2 How to Replace the PRO LC unit

Drive system and circuit board must be protected from moisture. Exchanges should only be done in a dry place and it must be ensured that no moisture enters the drive unit.

- a) Turn the protection cover on the drive unit counter-clockwise and remove it.
- b) Remove the empty PRO LC unit. The display indicates “LL” and the red LED is blinking.
- c) Remove the used battery set from the drive unit.
- d) Insert the new battery set into the drive unit. Follow the directions of the arrows.
- e) Remove the plug of the PRO LC unit (refer to figure 5, chapter 4.2).
- f) Push the PRO LC unit into the protection cover until lubricant comes out of the opening (refer to figure 6, chapter 4).
- g) Place the new PRO LC unit on the drive unit, turn it until the catch locks and the teeth of the PRO LC unit and the drive unit interlock. The control system automatically recognizes the new PRO LC unit. The display indicates “--” if the perma PRO was switched off prior to the replacement of the PRO LC unit. Or it indicates “99 % Vol.” if the perma PRO was switched on before the replacement. You should only use completely full perma-tec PRO LC units, in order to guarantee a trouble-free operation.
- h) The lubrication system continues to operate with the previous setting of the discharge period.
- i) If required, change lubricator settings (see chapter 6.8).



**If the lubricator was ON before changing the LC unit, it will automatically resume operation with existing settings. If the lubricator was OFF, it must be turned ON (refer to figure 13, chapter 6.5).**

## 8. Trouble Shooting

### 8.1 Error Messages on the Display

Possible errors of the lubrication system and the application are detected by the electronic control system and are indicated on the display. If an error is displayed, the system is switched OFF until the cause of the error has been eliminated and the error message has been acknowledged.



**Error messages are acknowledged and reset by pushing the ON/OFF/SELECT button.**

### 8.2 Trouble Shooting Guide

If there are malfunctions during the operation of the lubrication system, please check for possible causes using the following chart (refer to chart 7).

**Every time that an error message is displayed, the red LED is also blinking.**

Indication of the display	Error	Possible cause	Remedial measures
<i>E1</i>	Lubricator has been switched off	Excess motor current of the lubricator motor due to a blocked outlet  Battery set is empty	Clear the blockage and acknowledge the fault by pushing and holding down the ON/OFF/SELECT button  Insert a new battery set and use a full PRO LC unit
<i>E4</i>	Lubricator has been switched off	Drive mechanism is defective	Exchange the drive unit
<i>LC</i>	System does not detect the PRO LC unit	No PRO LC unit installed	Install an PRO LC unit
<i>Lo</i>	No power supplied to the system from the battery	No battery inserted or battery set empty	Insert a new battery set and use a full PRO LC unit
<b>In addition to the above, the following malfunctions can occur when a perma MP-6 distributor is connected to the lubrication system:</b>			
<i>E0</i>	Lubrication system has been switched off	Excess motor current of the perma MP-6	Replace perma MP-6 distributor
<i>F1 to F6</i>	Error at the displayed lubrication point	Excess motor current of the lubricator motor caused by a blocking of the displayed outlet	Clear the blockage and acknowledge the fault by pushing and holding down the ON/OFF/SELECT button
<i>E2</i>	Lubrication system has been switched off	Outlets of distributor not correctly recognized	Replace distributor
<i>E3</i>	Lubrication system has been switched off	Timeout while activating distributor  Connection cable damaged	Replace distributor  Replace connection cable
<i>E5</i>	Outlet configuration missing	Outlets were not activated	Activate desired outlets

chart 7

## 9. Accessories and Spare Parts

Due to the high pressure of up to 25 bar (360 psi), you should only use **genuine** spare parts and accessories from perma-tec in order to ensure a reliable operation of the distributor and the complete lubrication system. This especially applies to connections and lubricant tubes.

 **Spare parts and accessories must meet the technical requirements!**  
**This is always guaranteed with genuine spare parts and accessories from perma-tec.**

Spare parts	Part. No.	Illustration
PRO LC 250 filled with lubricant	222 XXXX*) 608  *) XXXX = grease number	
PRO LC 500 filled with lubricant	223 XXXX*) 609  *) XXXX = grease number	
PRO Cover for LC 250 made of transparent plastic	2299 101 000	
PRO Cover for LC 250 made of aluminium for applications with ester-containing lubricants	2299 102 001	
PRO Cover for LC 500 made of transparent plastic	2299 102 000	
PRO Cover for LC 500 made of aluminium for applications with ester-containing lubricants	2299 102 002	
PRO Battery B (0 °C to +60 °C / 32 °F to 140 °F)	2299 001 606	
PRO Battery B plus (-20 °C to +60 °C / -4 °F to +140 °F)	2299 002 607	

chart 8a

Spare parts	Part. No.	Illustration
perma PRO Mounting Device	27 008 007	
Grease cartridge 400 g filled with to be used for pre-filling grease lines with a grease gun	on request	
Tube Connector G1/8a for tube aØ 8 mm straight	27 008 010	
Tube Connector G1/8a for tube aØ 8 mm 90°	27 008 011	
PRO tube 8 x 1.5 (inner-Ø 5 mm) with different lengths	27 008 009	
Reducer G3/8 – G1/4	27 008 017	
CD ROM with SELECT software (calculation of the lubricant amount), lubrication and maintenance schedule and operating instructions as PDF file	on request	

chart 8b

## 10. Disposal

 Help us in protecting the environment and saving resources by recycling valuable raw material. Please follow your local waste disposal regulations.

## 11. Service

- ◆ Please contact your local supplier for availability and cost of the following:
  - Returning of the empty lubricator for environmentally safe recycling or disposal.

or:

  - exchange of battery set.
  - exchange of PRO LC unit.
  - to pre-set lubricator (LC/lubrication period/outlets)

## 12. Declaration of conformity for perma PRO

### EC declaration of conformity

- according to the Machinery Directive 98/37/EC<sup>[1]</sup> and according to EMV (Electromagnetic Compatibility) – Directive 2004/108/EC
- according to the Machinery Directive 2006/42/EC<sup>[2]</sup> and according to EMV (Electromagnetic Compatibility) – Directive 2004/108/EC

The manufacturer

**perma-tec GmbH & Co. KG**  
**Hammelburger Straße 21**  
**97717 Euerdorf**  
**Germany**

hereby declares that the product as described in the given statement conforms to the regulations appertaining to the directives referred to above, including any amendments thereto which are in force at the time of the declaration.

Product description: Automatic lubrication system  
 Product name: Lubrication system perma PRO  
 Type: perma PRO 250 and perma PRO 500

The following harmonised standards were applied:

EN ISO 12100-1:2003	Safety of machinery – basic concepts, general terms of reference as regards design and construction – Section 1: Basic Terminology, Methodology
EN ISO 12100- 2:2003	Safety of machinery – basic concepts, general terms of reference as regards design and construction – Section 2: Technical terms of reference
EN 60204 – 1:2006	Machinery's electrical equipment

Euerdorf, 11 February 2009

perma-tec GmbH & Co. KG

Walter Graf, Managing Director

Egon Eisenbacher, Technical management  
 and authorized documentation representative  
 (see manufacturer address)

This declaration certifies conformity to the directives referred to but it is not a warranty of qualities. The safety instructions of the operating manual are to be observed.

1. Directive 98/37/EC is valid until and including the 28<sup>th</sup> of December 2009.
2. Directive 2006/42/EC is valid as of 29 December 2009.

**perma-tec GmbH & Co. KG**

Hammelburger Str. 21  
97717 Euerdorf

Germany

Tel: +49 (0) 9704 609-0

Fax: +49 (0) 9704 609-50

E-mail: [info@perma-tec.com](mailto:info@perma-tec.com)

Homepage: [www.perma-tec.com](http://www.perma-tec.com)